

Article number: 2310426675

Description: E+G hinge with safety multiple switch CFSW 110-6-1NO+3NC-F-A
SUPER technopolymer (PA)

Measures

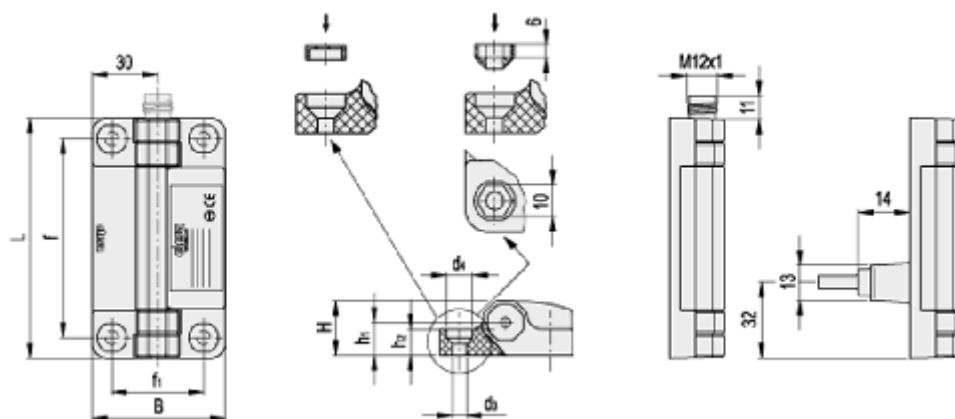

B = 60	L1 = 110
d3 = 6.5	
d4 = 12	
f = 91	
f1 = 42	
H = 25	
h1 = 15	
h2 = 12	